

TRXF

Thermal-Link & Fusing Resistor

TRXF2 Series



Description

Thermal-Link & Fusing Resistor (TRXF) is an unique type of Power Resistor, with Over Temp. and Over Current Protections. The Alloy Thermal-Link (ATCO) is built in the core of Fusible Wirewound Resistor (RXF) and in series with RXF.

TRXF is widely used in products such as general lighting, smart homes, small power home appliances, personal care application, security & protection.

SETsafe | SETfuse TRXF has the same physical size as ordinary RXF as well as large fault current protection. Besides, TRXF can effectively solve the hidden danger of continuous abnormal heat that ordinary RXF may cause when small fault current happens. TRXF2 series Rated Resistance from 0.27 Ω to 1,000 Ω, Rated Functioning Temp: 150 °C, 221 °C, safety certification includes cURus, TUV, CQC and complies with RoHS and REACH.

Features

- Over Temp. Protection
- Over Current Protection
- Small Fault Current Protection
- Surge Protection
- Inrush Current Protection
- RoHS & REACH Compliant

Applications

- Adapters
- Switched-Mode Power Supplies
- LED Drives
- Small Power Home Appliances
- Security & Protection

Customization

- Taping Packing Available
- Leads Forming Types

Structure Diagrams

Case Type

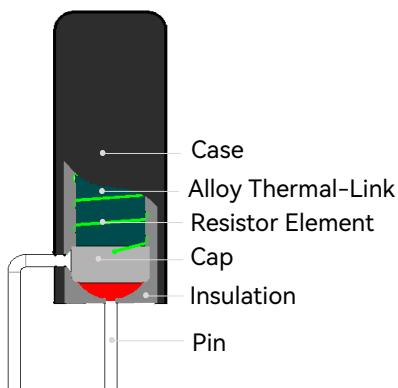

Note: The color of schematic diagram is for reference only

Dimensions (mm)

Vertical

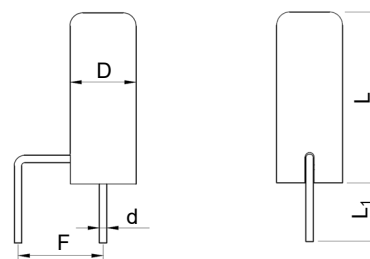

| L | L ₁ ^a | D | d | F ^a |
|-----------|-----------------------------|------------|--------------|----------------|
| 13.5 Max. | 3.5 ± 0.5 | Φ4.8 ± 0.2 | Φ0.54 ± 0.05 | 5.0 ± 0.5 |

Horizontal

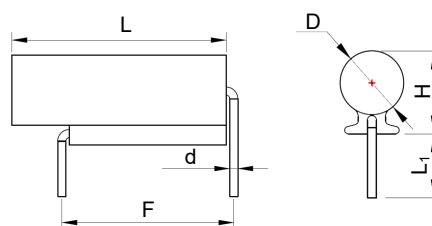

| L | L ₁ ^a | H | D | d | F ^a |
|-----------|-----------------------------|-----------|------------|--------------|----------------|
| 13.5 Max. | 3.5 ± 0.5 | 6.0 ± 0.2 | Φ4.8 ± 0.2 | Φ0.54 ± 0.05 | 10.0 ± 0.5 |



Note: a - F, L₁ and the bending mode of pins can be customized as required.

TRXF

Thermal-Link & Fusing Resistor

TRXF2 Series

Agency Information

| Agency Symbol | Standards | The File No. and certification No. obtained by SETsafe SETfuse | Rated Resistance (Ω) |
|---|-----------|--|----------------------|
|  cURus | UL 1412 | E324712 | 0.27 to 1,000 |
|  CQC | SJ 2865 | CQC15001126561 | 0.27 to 1,000 |
|  TUV | IEC 60065 | R50279979 | 2 to 1,000 |

Marking

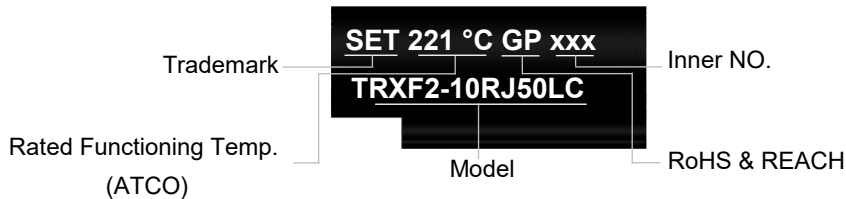

Part Numbering System

TRXF 2 - 4R7 J 50 L A A - 001

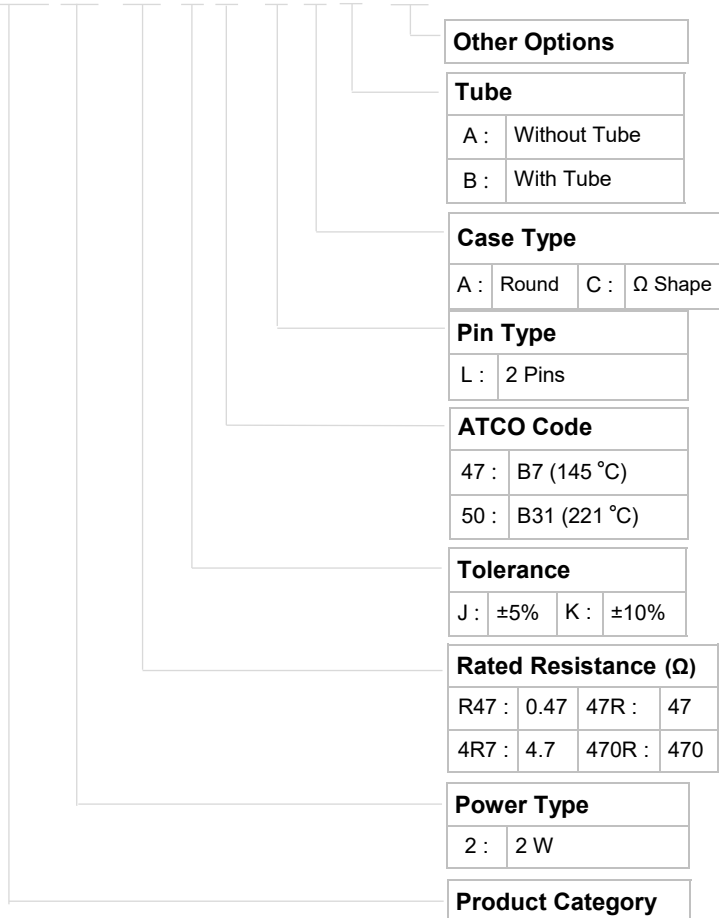

Technical Parameter



| Item | Parameter |
|--|--|
| Power Type (<i>P</i>) | 2 W |
| Rated Resistance (<i>R</i>) | 0.27 Ω ~ 1,000 Ω |
| Resistance Tolerance | 5% (E24), 10% (E12) |
| Derating Factor (<i>f</i>) | See Rated Power Derating Curve |
| Actual Power (<i>P₀</i>) | $P_0 = P \times f$ |
| Rated Current (<i>I_N</i>) | $I_N = \sqrt{P_0 / R}$ |
| Rated Voltage (<i>U_N</i>) | $U_N = \sqrt{P_0 \times R}$ |
| Fusing Time (less than 60 seconds) | $T_f = 221 \text{ °C}: 3 \times P$ $T_f = 150 \text{ °C}: 2 \times P$ |
| Rated Functioning Temp. (<i>T_f</i>) | 150 °C, 221 °C |
| Fusing Temp. (<i>T_F</i>) | $T_f = 221 \text{ °C}: 216 \text{ °C} \sim 221 \text{ °C}$ $T_f = 150 \text{ °C}: 143 \text{ °C} \sim 147 \text{ °C}$ |
| Surge (For Reference) | 2.0 kV (<i>R</i> > 10 Ω) |
| Note: Combination Wave | 1.0 kV (<i>R</i> ≤ 10 Ω) |

TRXF

Thermal-Link & Fusing Resistor

TRXF2 Series

Specifications

| Series | Power Type | Derating Factor (25 °C) | Rated Resistance (R) | Resistance Tolerance | Rated Functioning Temp. (T _f) | Fusing Temp. (T _F) | Agency Information | | | Environmental Status | |
|--------|------------|-------------------------|----------------------|----------------------|---|--------------------------------|--|---|---|----------------------|-------|
| | | | | | | |  |  |  | RoHS | REACH |
| | | | | | | | cURus | TUV | CQC | | |
| TRXF2 | 2 | 60 | 0.27 ~ 2.0 | ± 5, ± 10 | 150 | 143 ~ 147 | ● | N/A | ● | ● | ● |
| | | 80 | | | 221 | 216 ~ 221 | | | | | |
| | | 60 | 2.2 ~ 1,000 | ± 5, ± 10 | 150 | 143 ~ 147 | ● | ● | ● | ● | ● |
| | | 80 | | | 221 | 216 ~ 221 | | | | | |

Note: "●" Means certificated, RoHS & REACH Compliant .

Resistance Selection Table (According to IEC60063-2015, blue font is SETsafe | SETfuse common resistance).

| Rated Resistance (Ω) | Code | Rated Resistance (Ω) | Code | Rated Resistance (Ω) | Code | Rated Resistance (Ω) | Code |
|----------------------|------|----------------------|------|----------------------|------|----------------------|------|
| 0.10 | R10 | 1.0 | 1R0 | 10 | 10R | 100 | 100R |
| 0.11 | R11 | 1.1 | 1R1 | 11 | 11R | 110 | 110R |
| 0.12 | R12 | 1.2 | 1R2 | 12 | 12R | 120 | 120R |
| 0.13 | R13 | 1.3 | 1R3 | 13 | 13R | 130 | 130R |
| 0.15 | R15 | 1.5 | 1R5 | 15 | 15R | 150 | 150R |
| 0.16 | R16 | 1.6 | 1R6 | 16 | 16R | 160 | 160R |
| 0.18 | R18 | 1.8 | 1R8 | 18 | 18R | 180 | 180R |
| 0.20 | R20 | 2.0 | 2R0 | 20 | 20R | 200 | 200R |
| 0.22 | R22 | 2.2 | 2R2 | 22 | 22R | 220 | 220R |
| 0.24 | R24 | 2.4 | 2R4 | 24 | 24R | 240 | 240R |
| 0.27 | R27 | 2.7 | 2R7 | 27 | 27R | 270 | 270R |
| 0.30 | R30 | 3.0 | 3R0 | 30 | 30R | 300 | 300R |
| 0.33 | R33 | 3.3 | 3R3 | 33 | 33R | 330 | 330R |
| 0.36 | R36 | 3.6 | 3R6 | 36 | 36R | 360 | 360R |
| 0.39 | R39 | 3.9 | 3R9 | 39 | 39R | 390 | 390R |
| 0.43 | R43 | 4.3 | 4R3 | 43 | 43R | 430 | 430R |
| 0.47 | R47 | 4.7 | 4R7 | 47 | 47R | 470 | 470R |
| 0.51 | R51 | 5.1 | 5R1 | 51 | 51R | 510 | 510R |
| 0.56 | R56 | 5.6 | 5R6 | 56 | 56R | 560 | 560R |
| 0.62 | R62 | 6.2 | 6R2 | 62 | 62R | 620 | 620R |
| 0.68 | R68 | 6.8 | 6R8 | 68 | 68R | 680 | 680R |
| 0.75 | R75 | 7.5 | 7R5 | 75 | 75R | 750 | 750R |
| 0.82 | R82 | 8.2 | 8R2 | 82 | 82R | 800 | 800R |
| 0.91 | R91 | 9.1 | 9R1 | 91 | 91R | 910 | 910R |

Rated Power Derating Curve (For Reference Only)

When the ambient temp. exceeds 25 °C, the rated power value declines as the following curve.

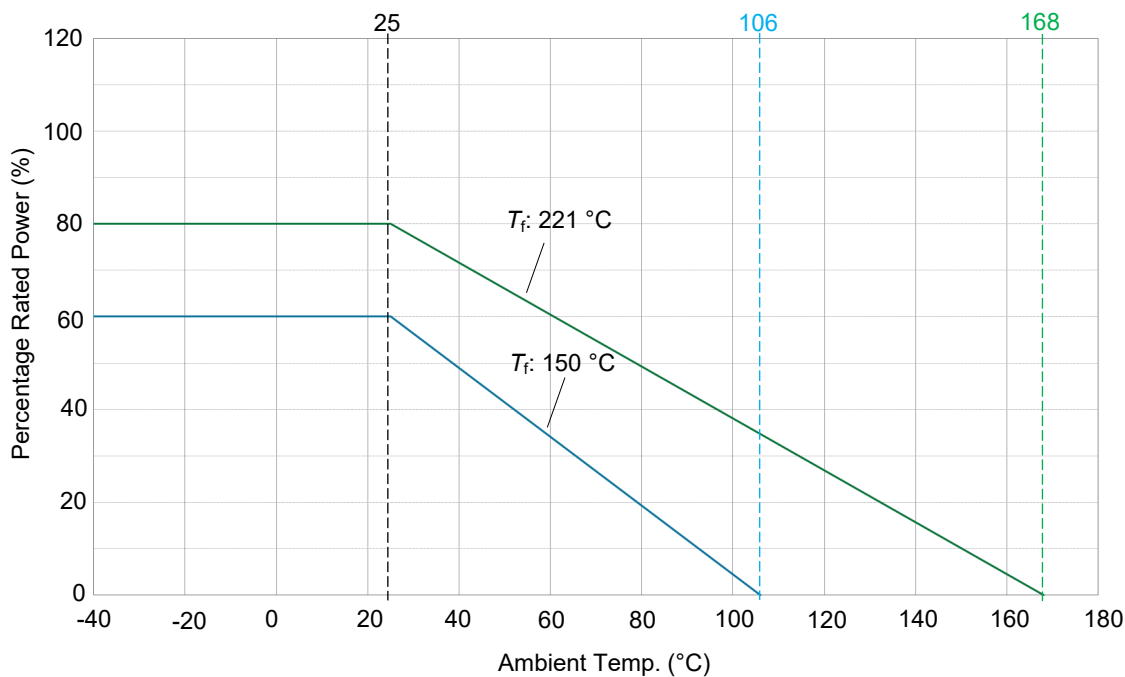

Fusing Time Curve (For Reference Only)

Compared with RXF, TRXF can open effectively at lower power multiples to protect the circuit timely. (ambient temp. 25 °C ± 2 °C)

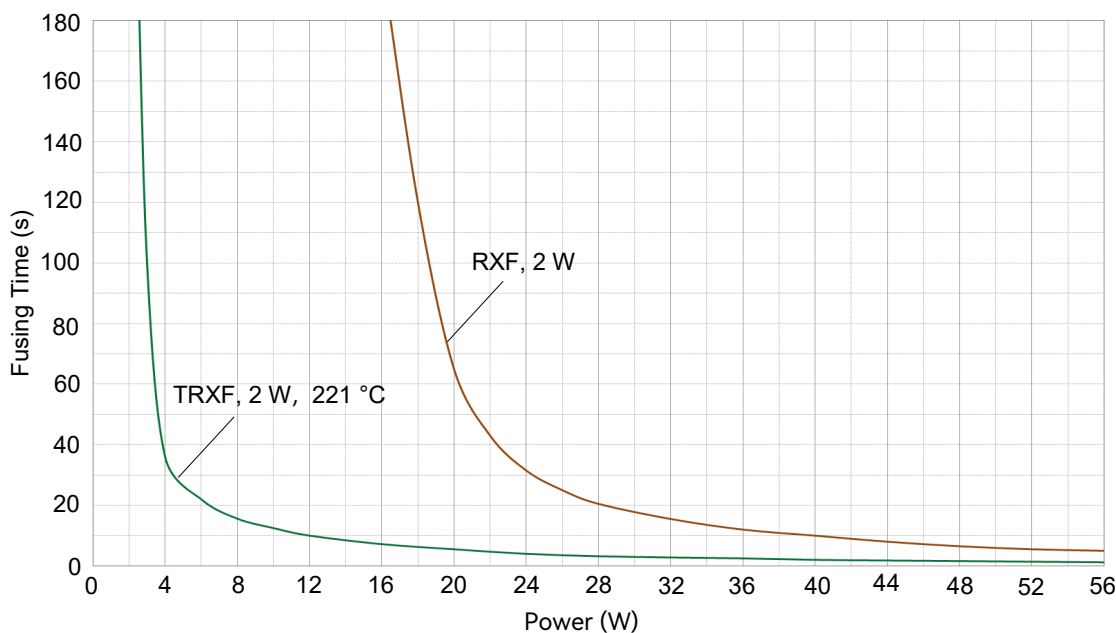

TRXF

Thermal-Link & Fusing Resistor

TRXF2 Series

Surface Temp. Curve (For Reference Only)

The surface temp. of TRXF is always at a lower level, when small fault current happens to the device, TRXF is able to open the circuit timely without additional damage (ambient temp. 25 °C ± 2 °C).

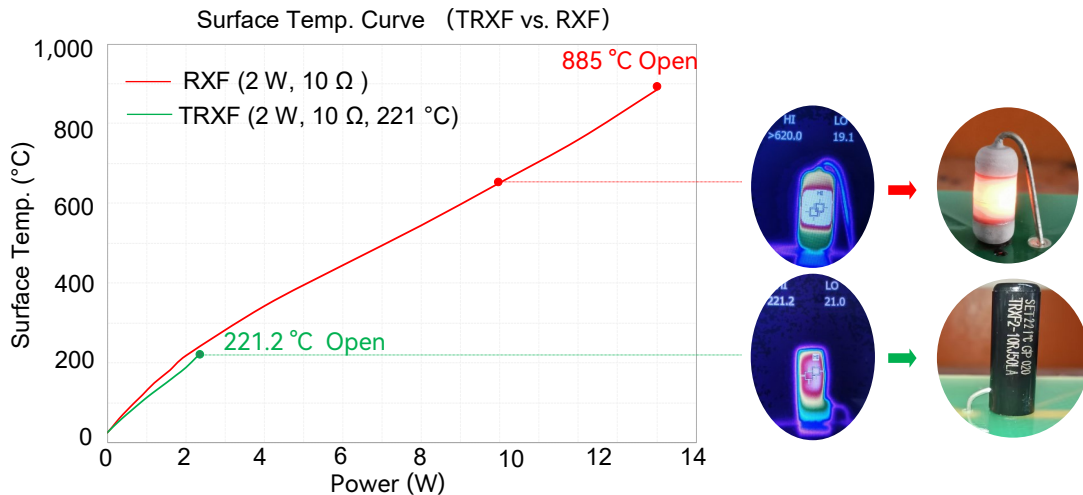

Packaging Information

Bulk

| Item | PE Bag | Box | Carton |
|--------------------------------|----------|---------------|-----------------|
| Dimensions (mm) | 135 × 85 | 255 × 88 × 98 | 480 × 280 × 230 |
| Quantity (PCS) | 100 | 2,000 | 20,000 |
| Gross Weight (Vertical) (kg) | | | 12 ± 10% |
| Gross Weight (Horizontal) (kg) | | | 14 ± 10% |

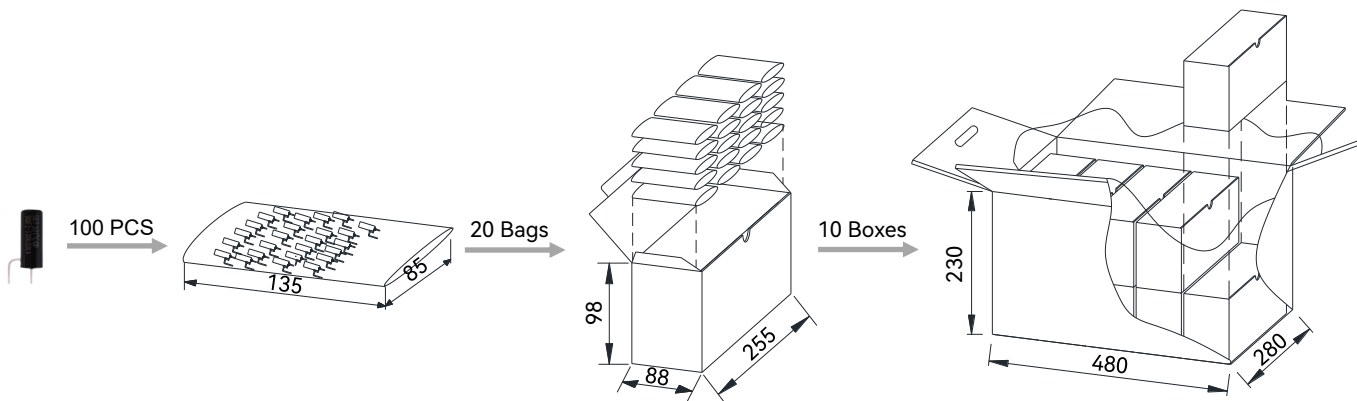

Glossary

| Item | Description |
|----------------|---|
| RXF | <p>Fusible Wirewound Resistor</p> <p>A power resistor which is made by winding a resistive element on a ceramic core, and the core is coated by insulation coating. It intends to interrupt a current flow at a predetermined time when the current exceeds a predetermined value. Fusible Wirewound Resistor is disposable fuse elements and is non-recoverable.</p> <p>— (SETsafe SETfuse Standards)</p> |
| ATCO | <p>Alloy Thermal-Link</p> <p>Alloy Type Thermal-Link, Alloy is the thermal element.</p> <p>— (GB/T 9816.3)</p> |
| R | <p>Rated Resistance</p> <p>Resistance value for which the resistor has been designed, and which is generally used for denomination of the resistor.</p> <p>— (IEC 60115-1)</p> |
| P ₀ | <p>Actual Power</p> <p>The Max. power of TRXF can be used within the allowable operating Temp. range.</p> <p>— (SETsafe SETfuse Standards)</p> |
| I _N | <p>Rated Current</p> <p>$I_N = \sqrt{P_0 / R}$</p> <p>— (SETsafe SETfuse Standards)</p> |
| U _N | <p>Rated Voltage</p> <p>The d.c. or a.c. r.m.s. voltage calculated from the square root of the product of the rated resistance and the rated dissipation.</p> <p>— (IEC 60115-1)</p> |
| T _f | <p>Rated Functioning Temp.</p> <p>The temp. of the Alloy Thermal-Link which causes it to change the state of conductivity with a detection current up to 10 mA as the only load.</p> <p>Tolerance: $T_f + 0 / -10$ °C (GB 9816.1, EN 60691, K60691)</p> <p>Tolerance: $T_f \pm 7$ °C (J60691)</p> <p>— (IEC 60691)</p> |
| T _F | <p>Fusing Temp.</p> <p>The temp. of the Alloy Thermal-Link which causes it to change its state of conductivity is measured with silicone oil bath in which the temp. is increased at the rate of 0.5 °C to 1 °C / minute, with a detection current up to 10 mA as the only load.</p> <p>— (IEC 60691)</p> |
| TCR | <p>Temp. Coefficient of Resistance</p> <p>Relative variation of resistance between two given temp. divided by the difference in the temp. producing it.</p> <p>— (IEC60115-1)</p> |



ATTENTION

Cold Resistance Test

1. If product TCR is not less than 350 ($10^{-6}/^{\circ}\text{C}$), the measured resistance value shall be corrected as the relative resistance value under 25 $^{\circ}\text{C}$ according to TCR formula.
2. Resistance Measurement (4-terminal test)

Replacement

As TRXF is a non-resettable product, for safety sake, please use the same type of TRXF for replacement.

Usage

1. Do not touch the resistor body or pins directly when power is on, to avoid burn or electric shock.
2. When air pressure is from 80 kPa to 106 kPa, the relative altitude shall be +2000 m to - 500 m.

Storage

1. Please store TRXF with ambient temp. 10 $^{\circ}\text{C}$ ~ 30 $^{\circ}\text{C}$ and relative humidity 30% ~ 75%.
2. Do not store the TRXF at the high temp., high humidity or corrosive gas environment, avoid influencing the solderability of the pins, please use them up within 1 year after receiving the goods.

Soldering Parameters

Wave Soldering Parameters (For Reference Only)

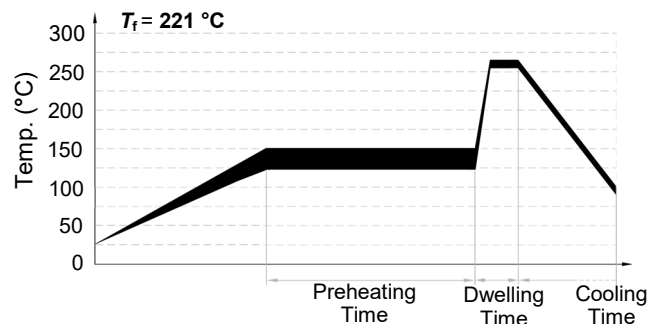
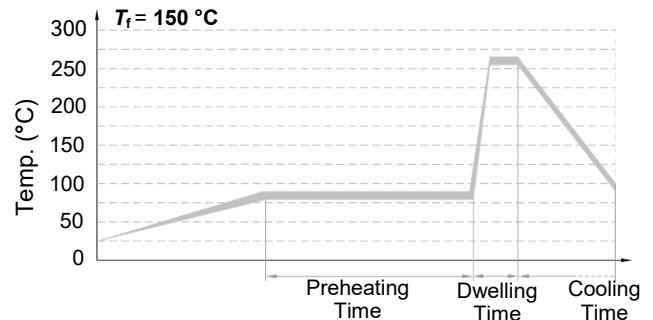







| Item | Temp. ($^{\circ}\text{C}$) | | Time (s) |
|------------|------------------------------|---------------------------|----------|
| | $T_r=150^{\circ}\text{C}$ | $T_r=221^{\circ}\text{C}$ | |
| Preheating | 80 ~ 90 | 120 ~ 150 | 60 ~ 100 |
| | 260 \pm 5 | 260 \pm 5 | |
| Dwelling | 260 \pm 5 | 260 \pm 5 | 4 ~ 5 |

Hand-Soldering Parameters

Solder Iron Temp.: (350 \pm 5) $^{\circ}\text{C}$

Soldering Time: ≤ 3 s ($T_r = 221^{\circ}\text{C}$) / ≤ 2 s ($T_r = 150^{\circ}\text{C}$)

Thermal-Link & Fusing Resistor (TRXF - Case Type) Features Overview

| | | | | | | |
|--|---|---|--|---|---|---|
| Shape |  |  |  |  |  |  |
| Structure | Vertical | Horizontal | Vertical | Horizontal | Vertical | Horizontal |
| R Resistance Range | (1.0 ~ 600) Ω | | (0.27 ~ 800) Ω | | (0.27 ~ 1000) Ω | |
| | According to IEC60063-2015, resistance can be customized. | | | | | |
| P Power Type | 1 W(S) | | 1 W | | 2 W | |
| Dimensions | Φ3.6 mm × 11.0 mm | | Φ4.8 mm × 11.0 mm | | Φ4.8 mm × 13.5 mm | |
| | The forming modes and length of lead wires can be customized. | | | | | |
| T_r Rated Functioning Temp. | 145 °C, 150 °C, 221 °C | | | | | |